

PA0	34	PA0 - WKUP
PA1	35	PA1
PA2	36	PA2
Flash_CS	PA3	PA3
Flash_SCK	PA4	PA4
Flash_MISO	PA5	PA5
Flash_MOSI	PA6	PA6
PA7	43	PA7
PA8	100	PA8
PA9	101	PA9
TX1	PA10	102
RX1	PA10	102
PA11	103	PA11
PA12	104	PA12
TMS/SWDIO	PA13	105
TCK/SWCLK	PA14	109
TDI	PA15	110
PA15	110	PA15

PB0	46	PB0
PB1	47	PB1
PB2	BOOT1	48
PB3	TD0	133
PB4	TRST	134
PB5	135	PB5
PB6	136	PB6
PB7	137	PB7
PB8	139	PB8
PB9	140	PB9
PB10	69	PB10
PB11	70	PB11
PB12	73	PB12
PB13	74	PB13
PB14	75	PB14
PB15	76	PB15

PC0	26	PC0
PC1	27	PC1
PC2	28	PC2
PC3	29	PC3
PC4	44	PC4
PC5	45	PC5
PC6	96	PC6
PC7	97	PC7
PC8	98	PC8
PC9	99	PC9
PC10	111	PC10
PC11	112	PC11
PC12	113	PC12
PC13	7	PC13-ANTI_TAMP
PC14	8	PC14-OSC32_IN
PC15	9	PC15-OSC32_OUT

PD0	114	PD0
PD1	114	PD1
PD2	115	PD2
PD3	116	PD3
PD4	117	PD4
PD5	118	PD5
PD6	119	PD6
PD7	122	PD7
PD8	123	PD8
PD9	77	PD9
PD10	78	PD10
PD11	80	PD11
PD12	80	PD12
PD13	81	PD13
PD14	82	PD14
PD15	86	PD15

VSS_1	71	VSS_1
VSS_2	107	VSS_2
VSS_3	143	VSS_3
VSS_4	38	VSS_4
VSS_5	51	VSS_5
VSS_6	61	VSS_6
VSS_7	83	VSS_7
VSS_8	94	VSS_8
VSS_9	120	VSS_9
VSS_10	130	VSS_10
VSS_11	130	VSS_11
VDD_1	108	VDD_1
VDD_2	144	VDD_2
VDD_3	39	VDD_3
VDD_4	17	VDD_4
VDD_5	52	VDD_5
VDD_6	62	VDD_6
VDD_7	84	VDD_7
VDD_8	95	VDD_8
VDD_9	121	VDD_9
VDD_10	131	VDD_10
VDD_11	131	VDD_11

**STM32F10x/STM32F40x**

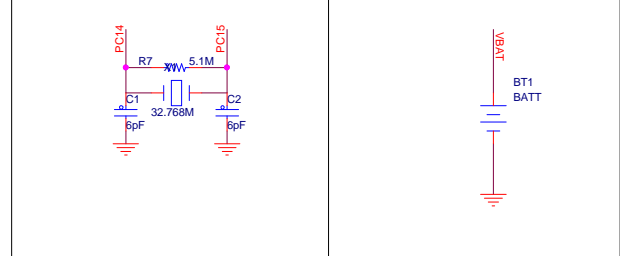
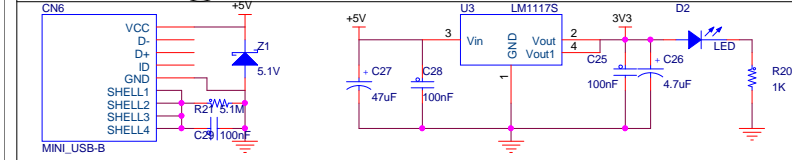

**RTC CLOCK**

**Batter**

**BOOT**

**LED**

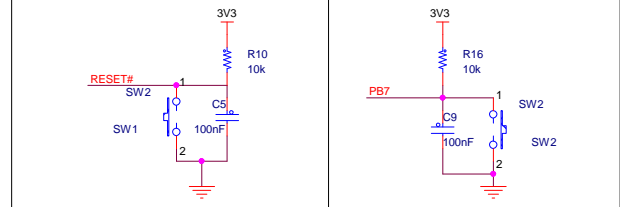

**RESET**

**KEY**

**Analog Power**

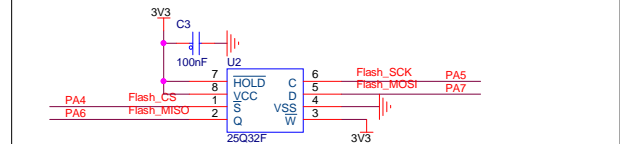
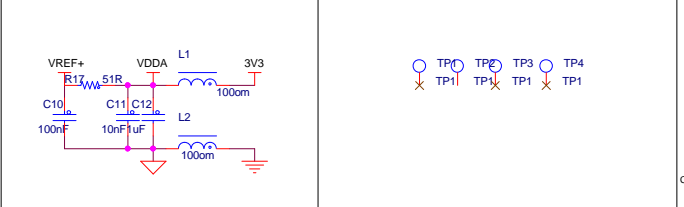

**SPI Flash**

**USART1 pin connectors**

PB14	1	2	PB15
PD8	3	4	PD9
PD10	5	6	PD11
PD12	7	8	PD13
PD14	9	10	PD15
PG2	11	12	PG3
PG4	13	14	PG5
PG6	15	16	PG7
PG8	17	18	PG9
PG9	19	20	PG10
PA9	21	22	PA8
PA11	23	24	PA10
PA13	25	26	PA12
PA15	27	28	PA14
PC11	31	32	PC12
PD0	33	34	PD1
PD2	35	36	PD3
PD4	37	38	PD5
PD6	39	40	PD7
PG9	41	42	PG10
PG11	43	44	PG12
PG13	45	46	PG14
PG15	47	48	PG16
PB4	49	50	PB5
PB6	51	52	PB7
PB8	53	54	PB9
PE0	55	56	PE1

**MCU GPIO pin connectors**

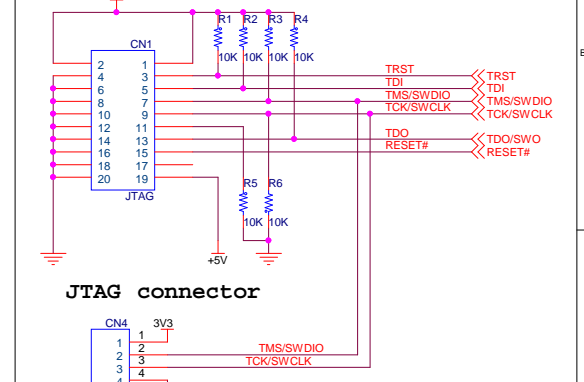

**JTAG connector**

**SWD Download/Dubeg connectors**

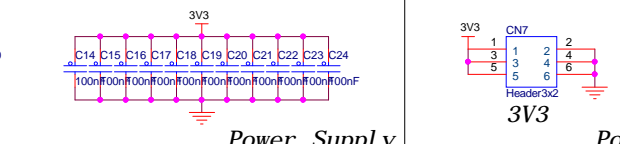

**Power Supply**

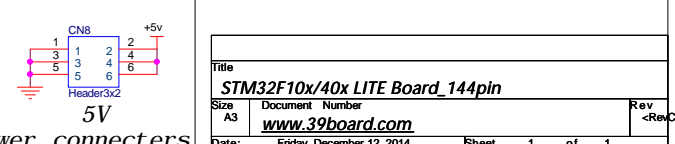

**Power connectors**

Title		<b>STM32F10x/40x LITE Board_144pin</b>	
Size	A3	Document Number	<a href="http://www.39board.com">www.39board.com</a>
Date:	Friday, December 12, 2014	Sheet	1 of 1